

# CC021-80CM Installation Instruction

									
A*24	B*24	C*52	D*2	E*4	F*4	G*8	H*40	I*2	
Eccentric screw		Eccentric bolt		Minimum self-tapping screw		handle	Handle screw	3CM flat head screw	
						Hinge	small nails		

The installation principle of the eccentric part: Reminder: When installing the screw, tighten it seven times, and then tighten it after all is completed!



1 Screw the eccentric screw onto the board

2 Find the corresponding board to insert

3

4 Insert the eccentric bolt into the round hole

5 Rotate 180° clockwise to lock the board

6

Board name and serial number:

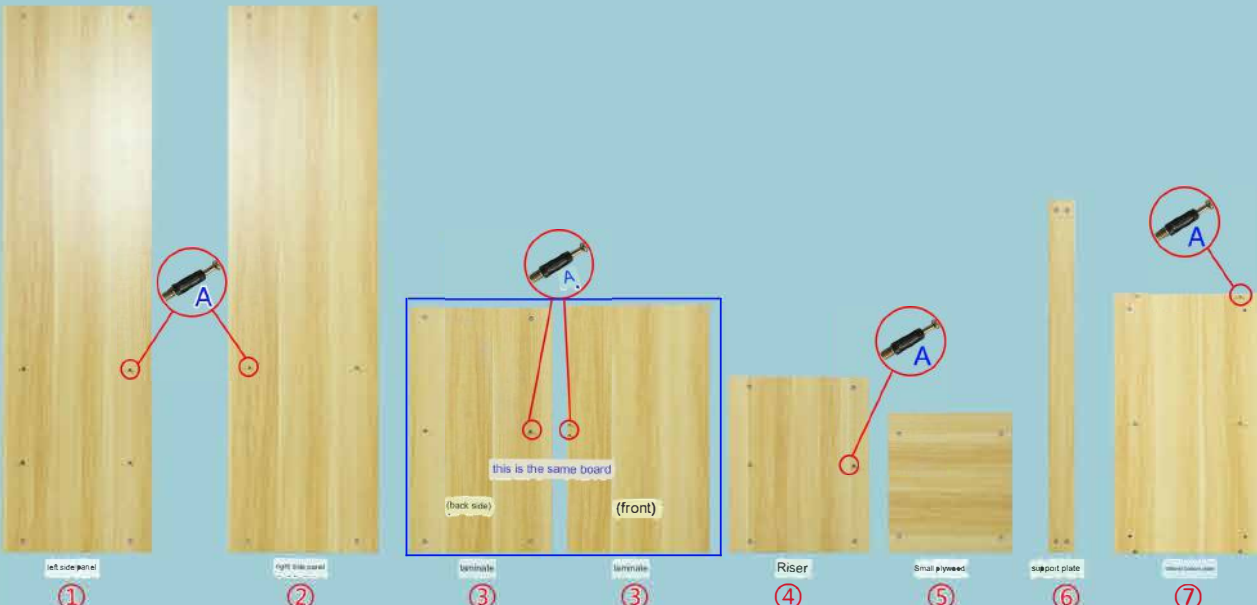

① left side panel

② right side panel

③ laminate (back side)

③ laminate (front)

④ Riser

⑤ Small plywood

⑥ support plate

⑦ support plate

this is the same board



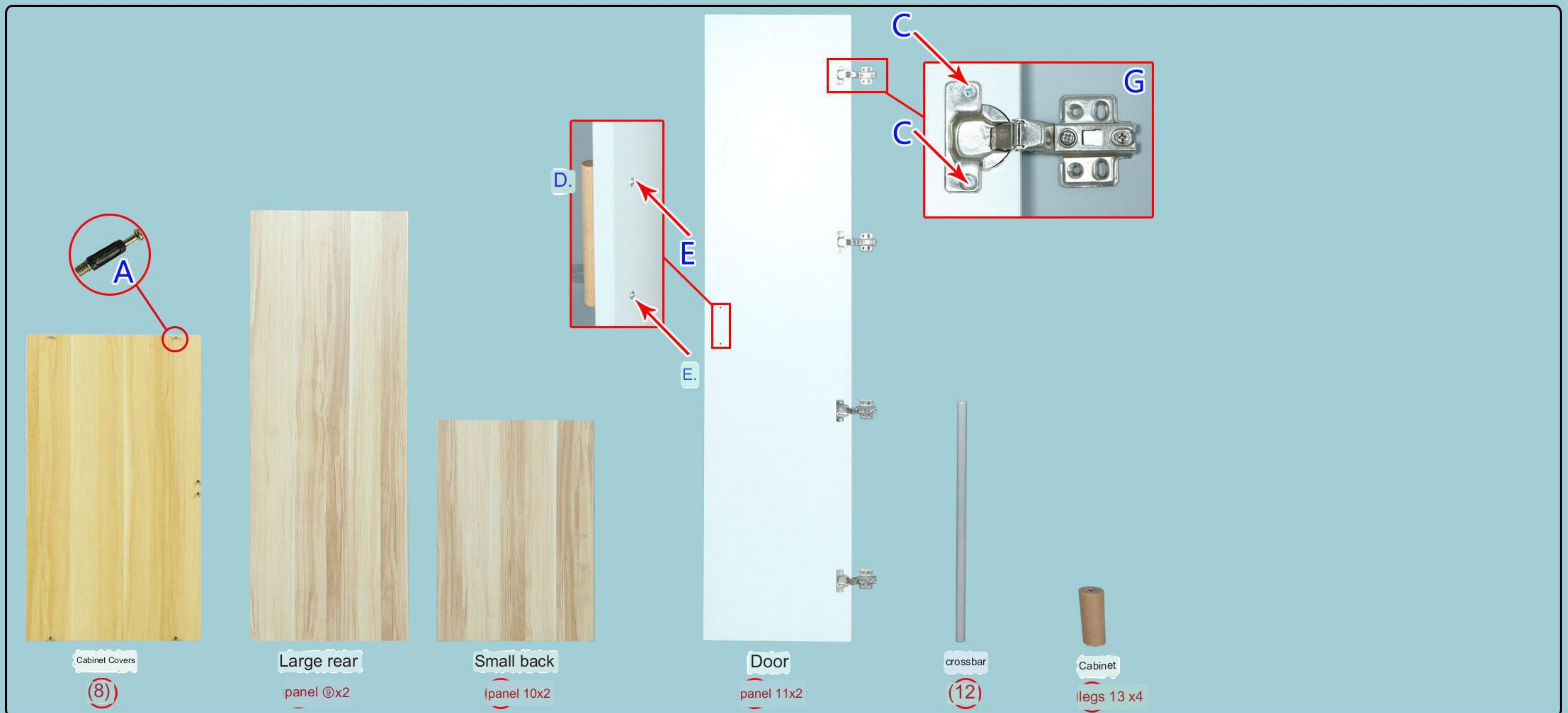

Step 1: Whole Parts Installation

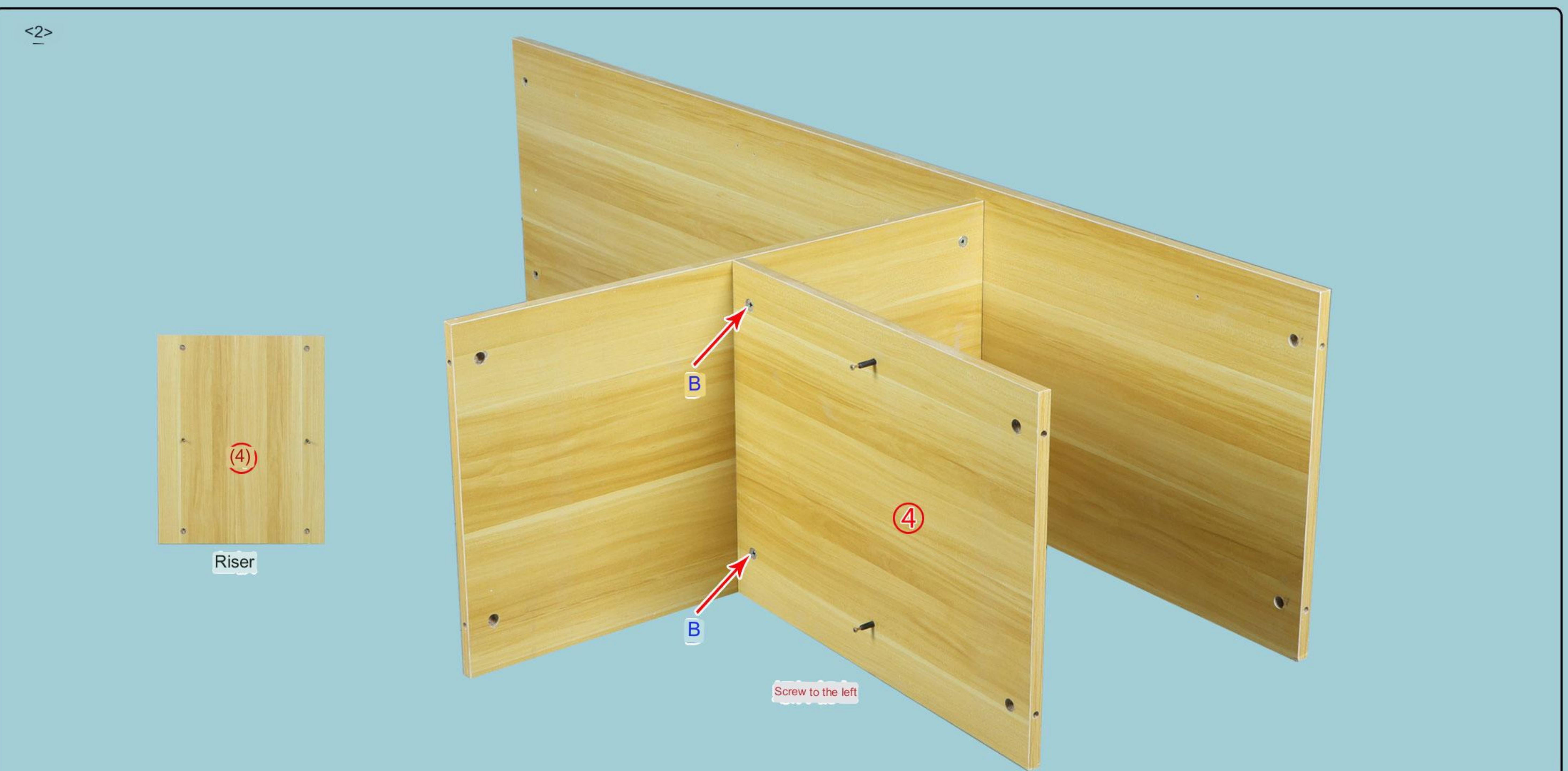



<3>

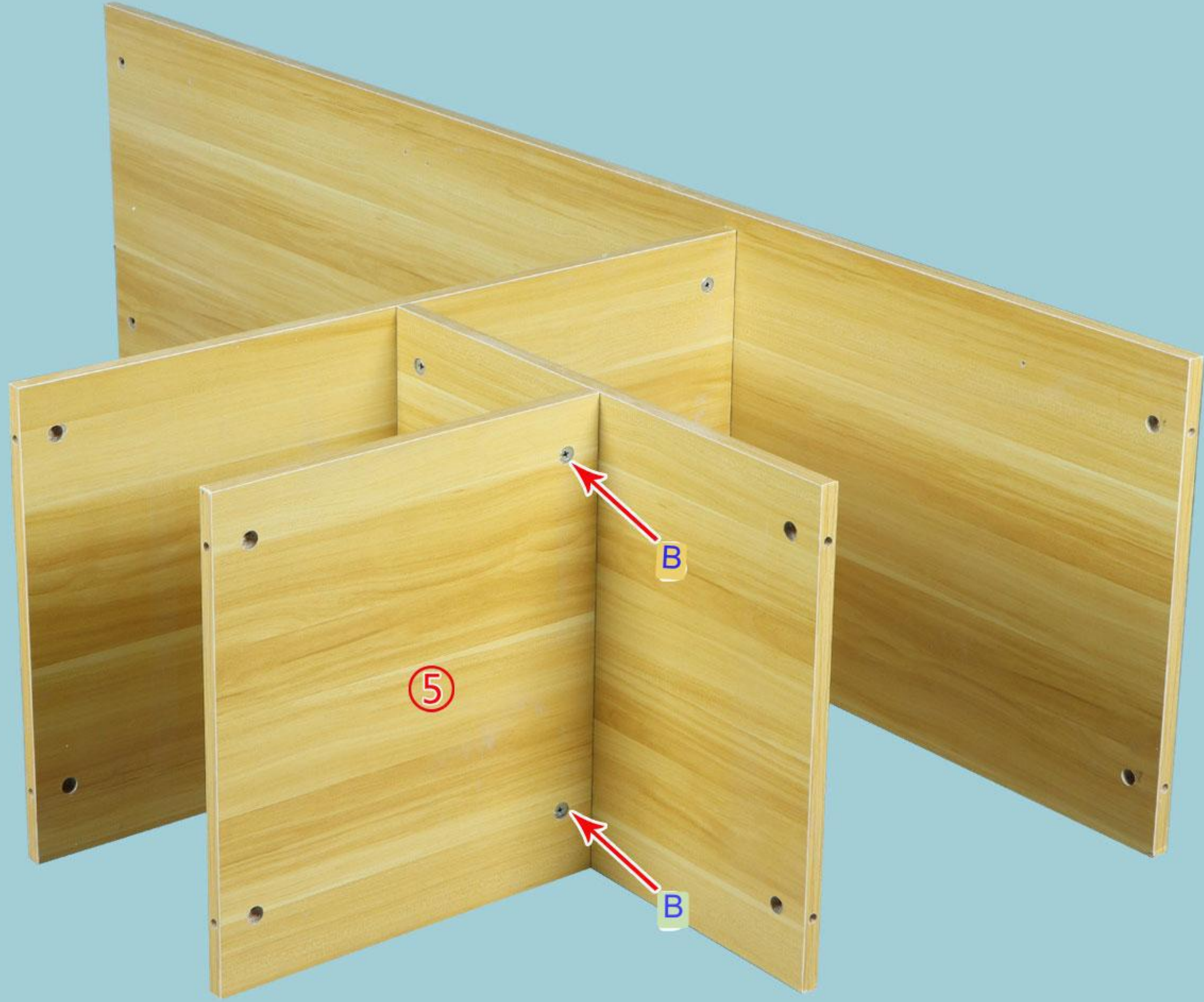

<4>



<5>

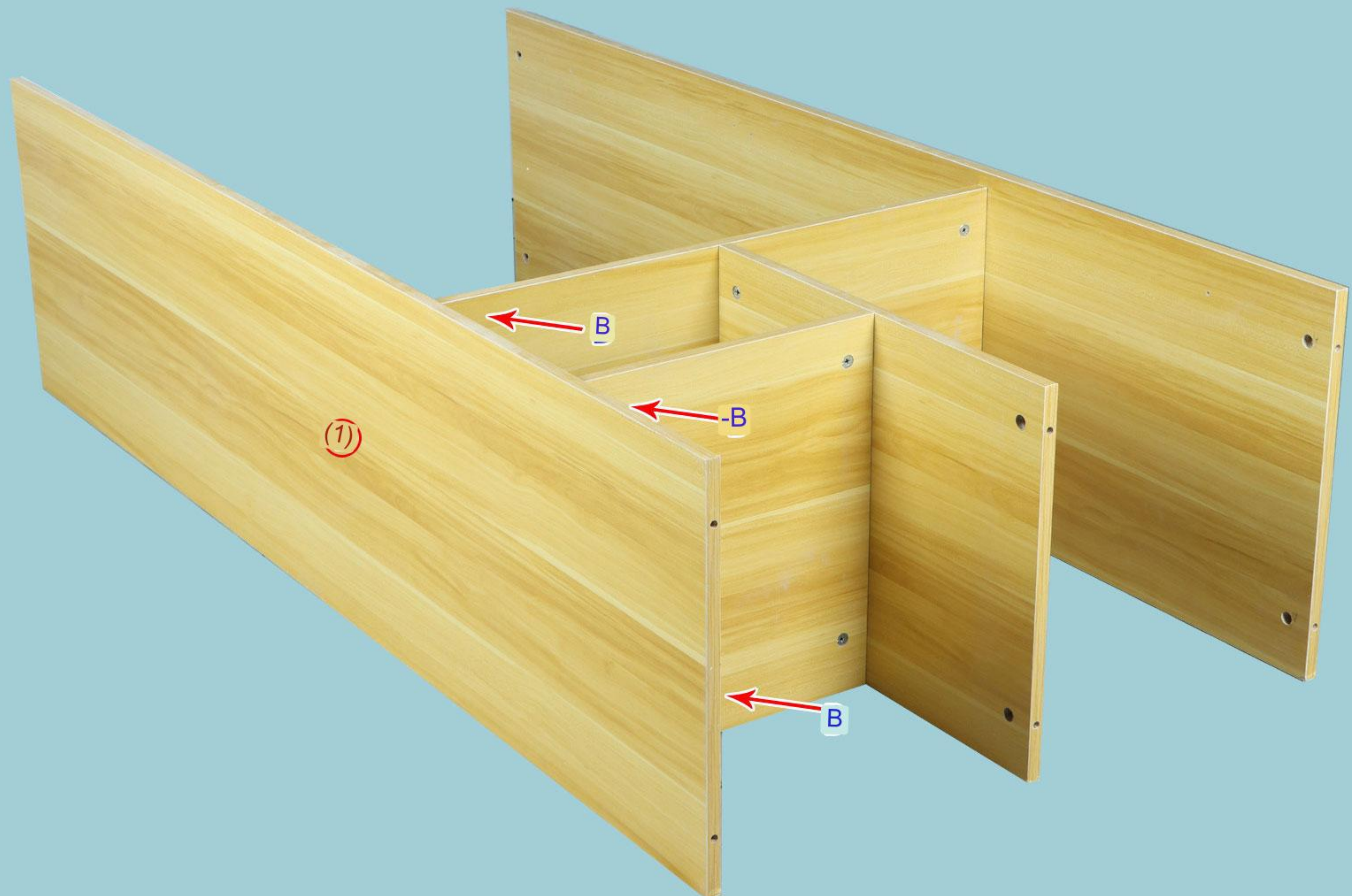



<6>

big hole side facing back



cabinet bottom plate

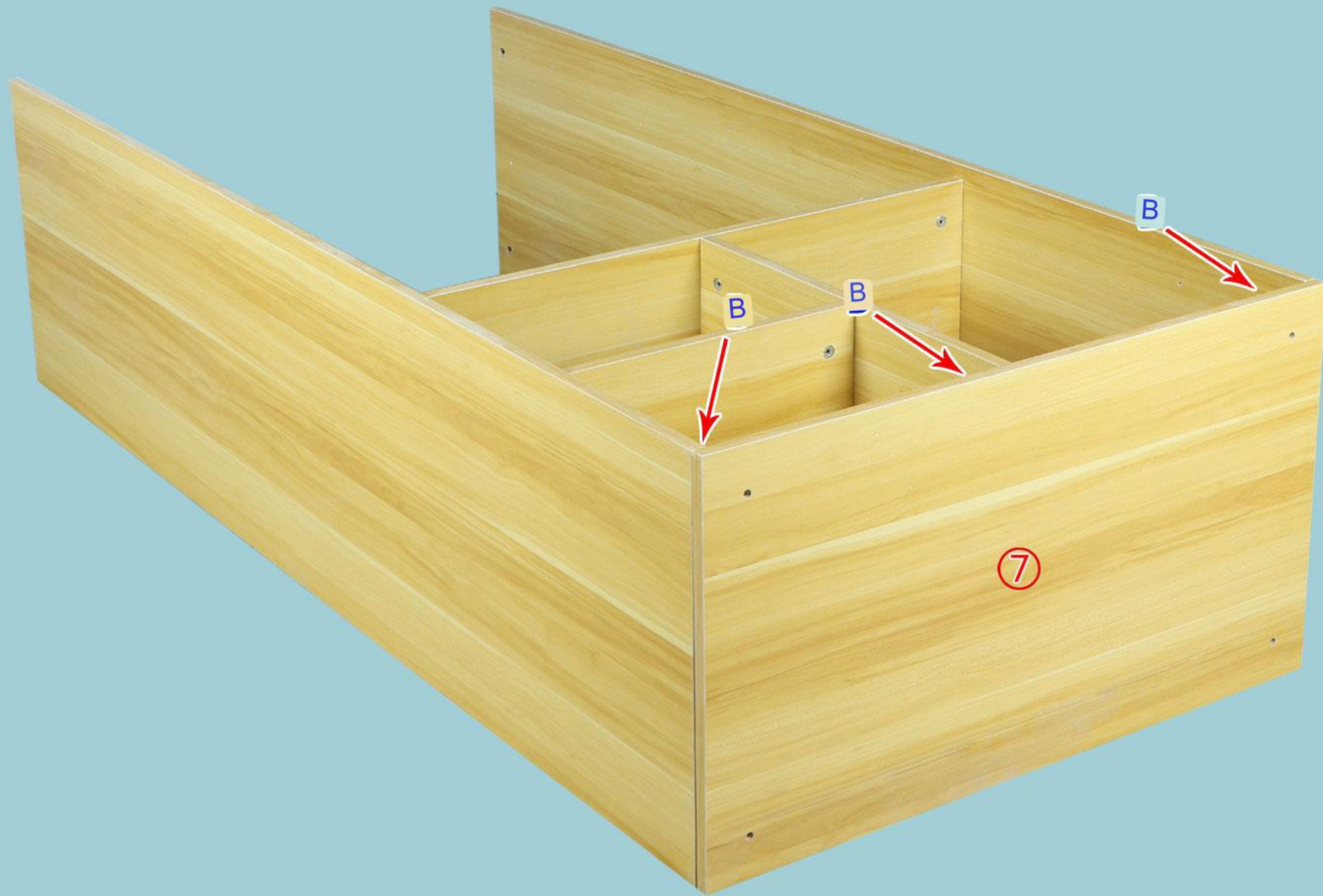

<7>



Cabinet feet (four in total)

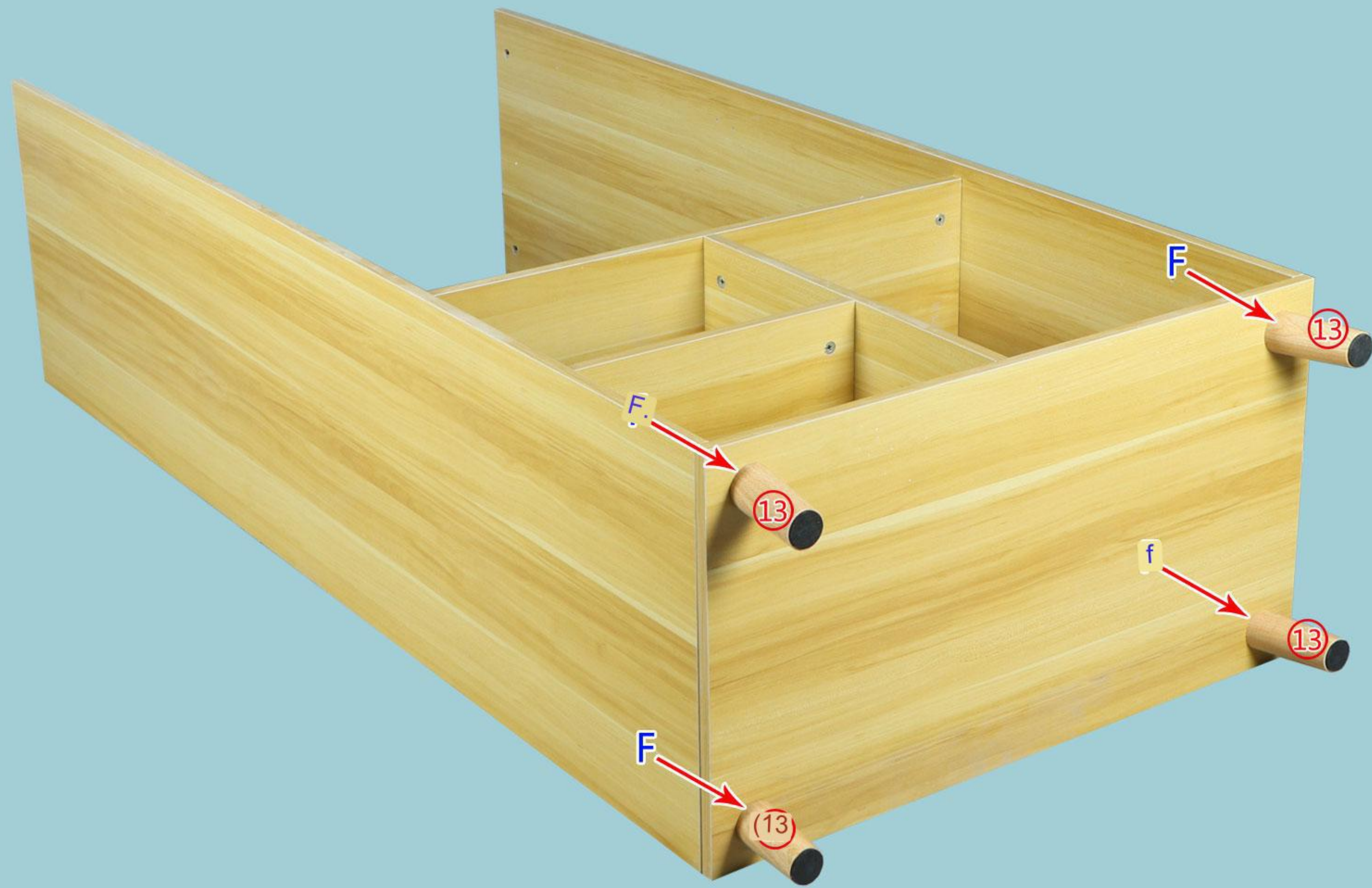

<8>



cabinet cover

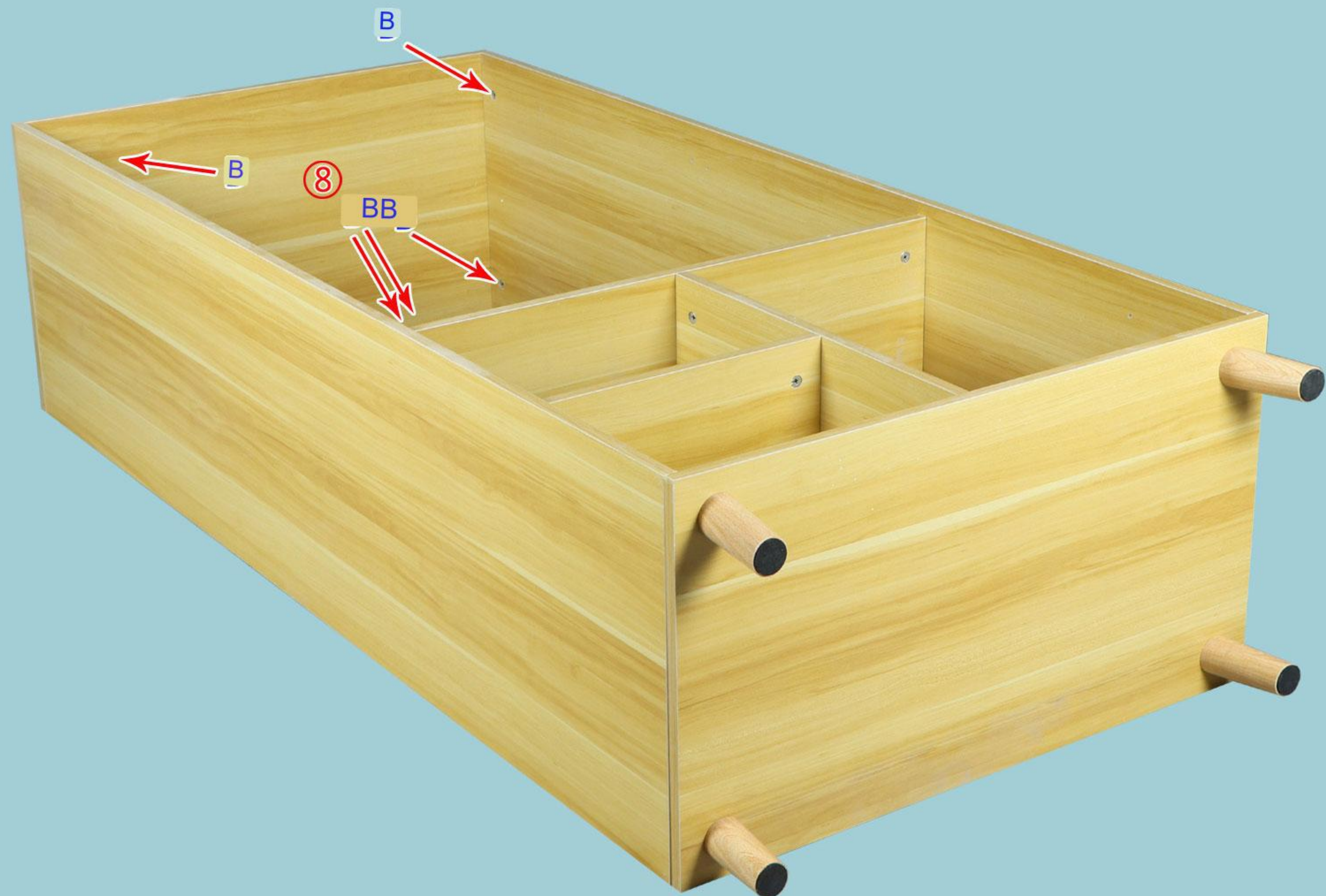



<9> Turn the whole over, the back side is up



Large back panel (two pieces in total)

Small back panel (two pieces in total)

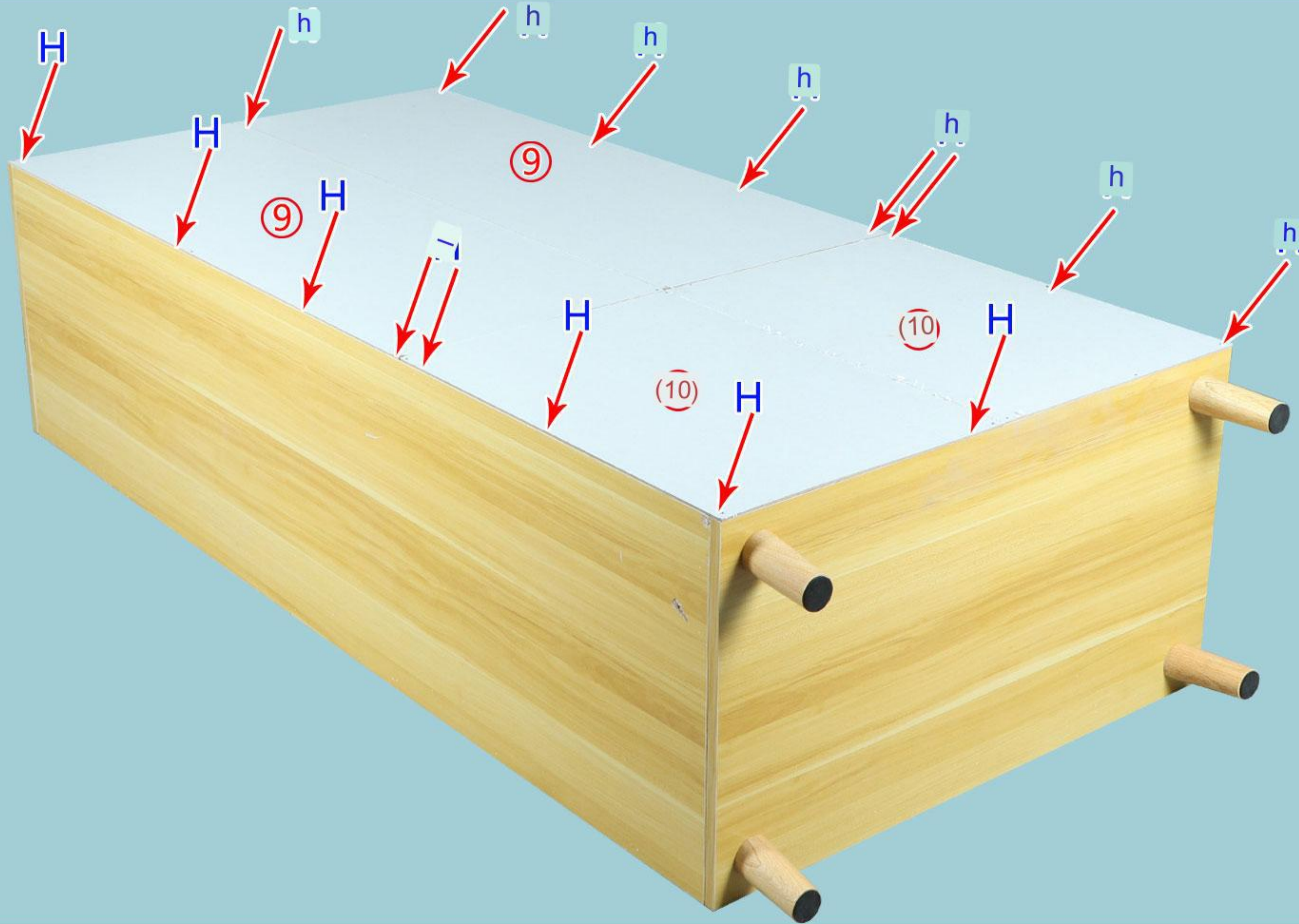

<10> straighten the whole



<11>



Find a suitable position, fix the clothes holder with the smallest self-tapping screw, and pay attention to the flushness on both sides

<12>

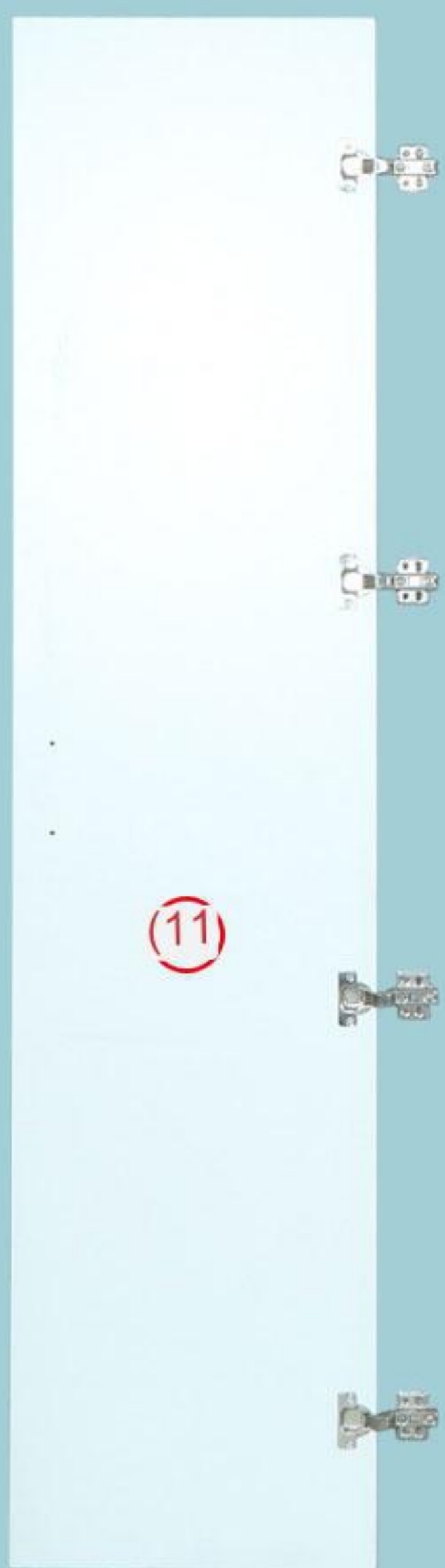

Door panels (two pieces in total)

If you don't know how to install hinges, you can ask the customer service for a detailed installation video.



Screw in two screws first, and then screw in all the screws after the board is adjusted.



# door adjustment

The door gap is too large

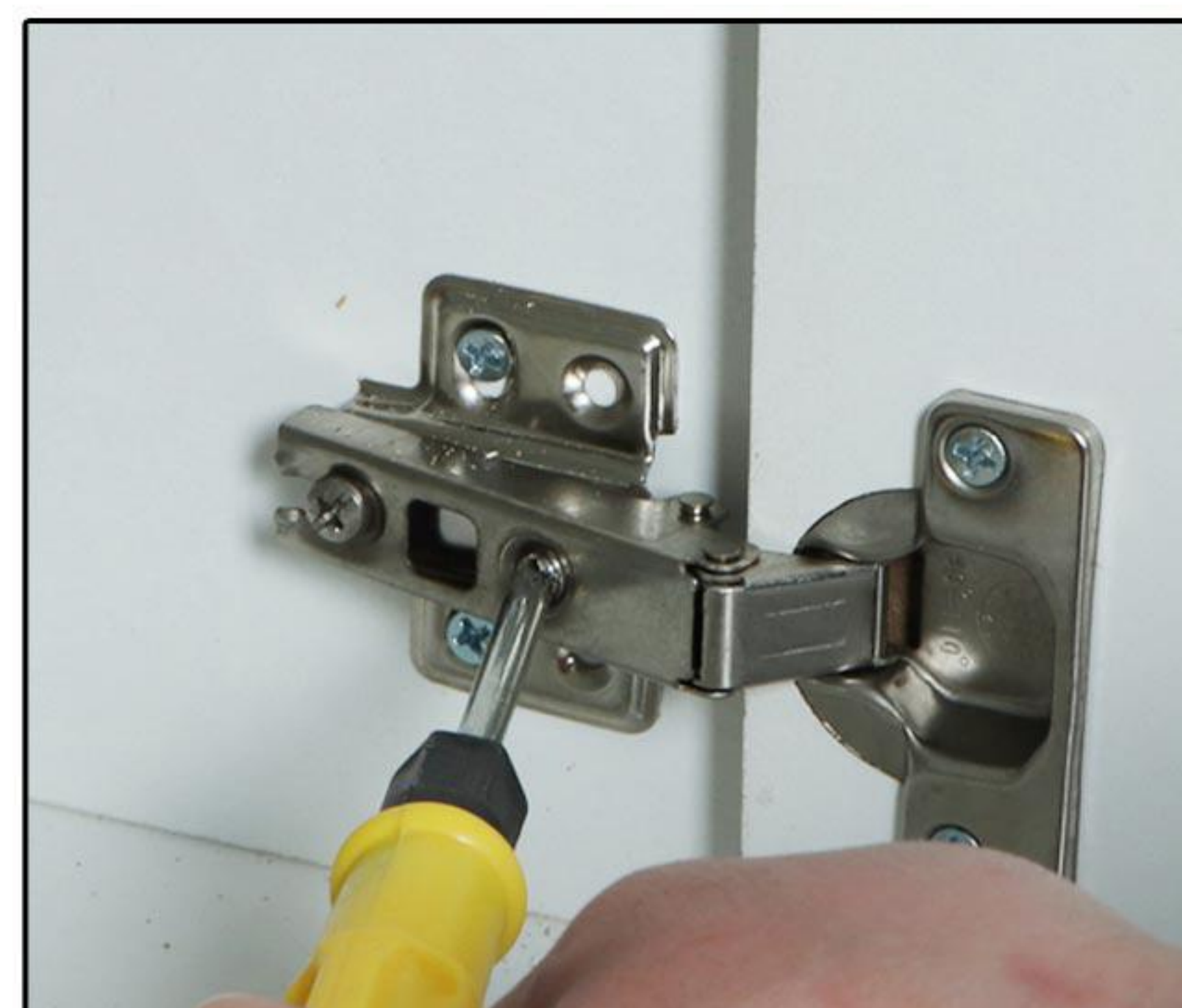
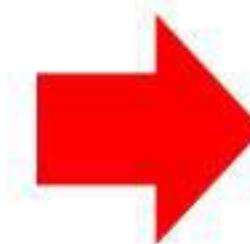

As shown in the figure, the screw that the screwdriver points to, it is to adjust the left and right movement of the door panel, and the clockwise rotation is to adjust the door panel to move to the middle.

The gap between the door panel and the side panel is too large

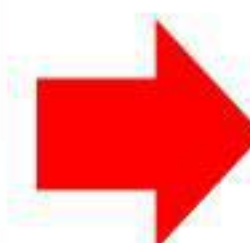
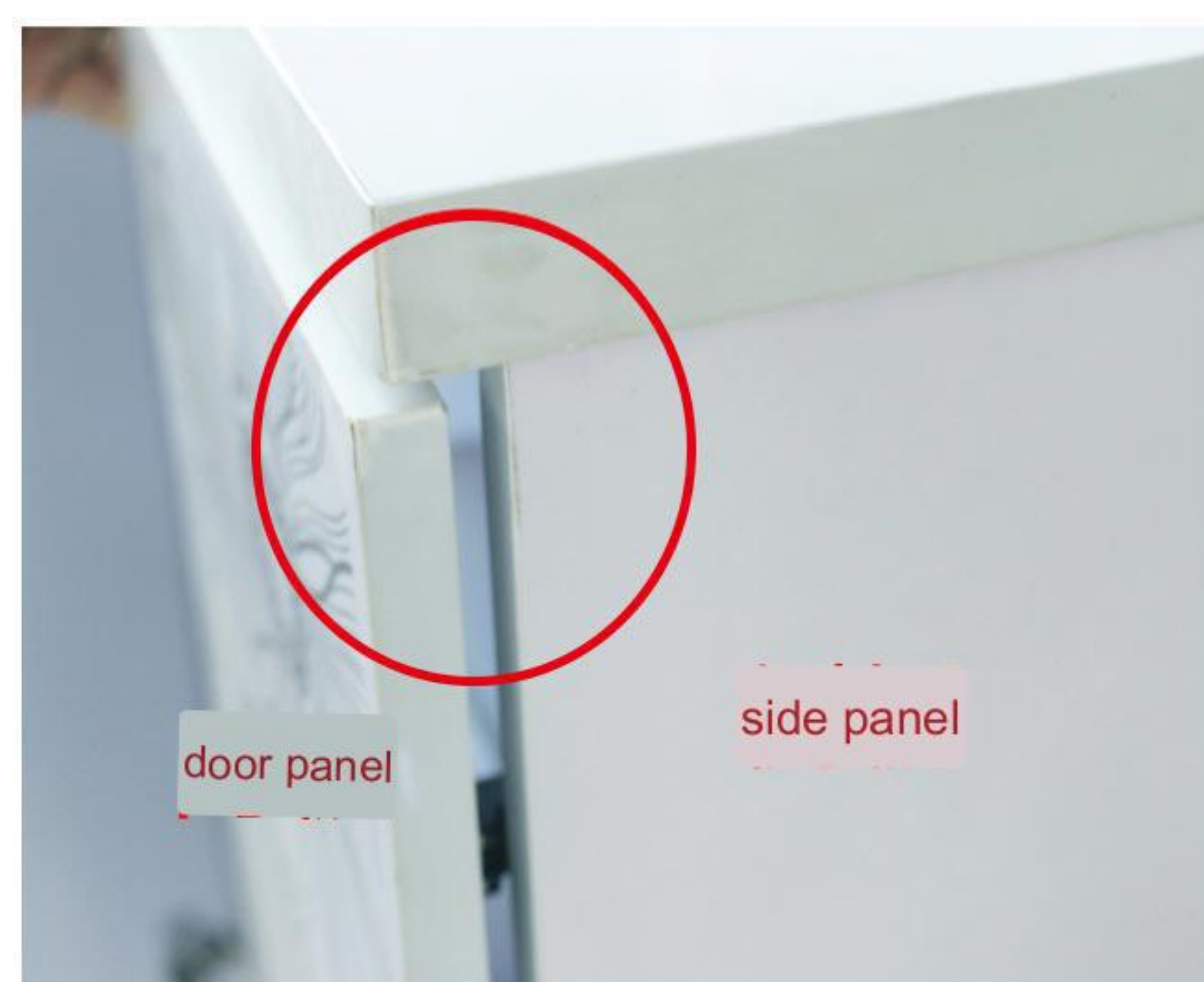

As shown in the picture, loosen the screw pointed by the screwdriver, push the door panel in or pull it out, and then tighten it to solve the above problem.

The height of the door panel is uneven

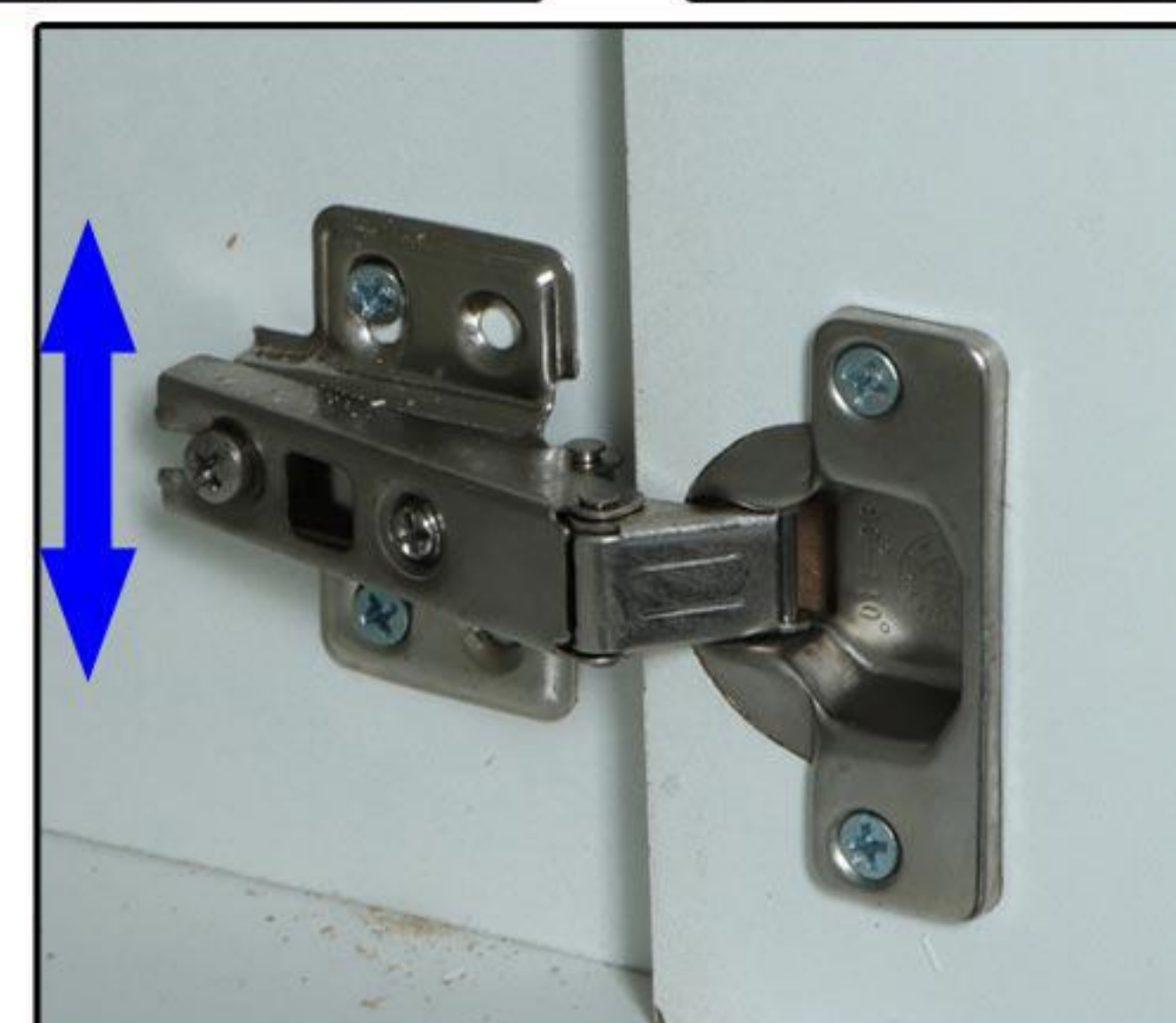
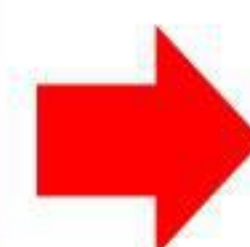
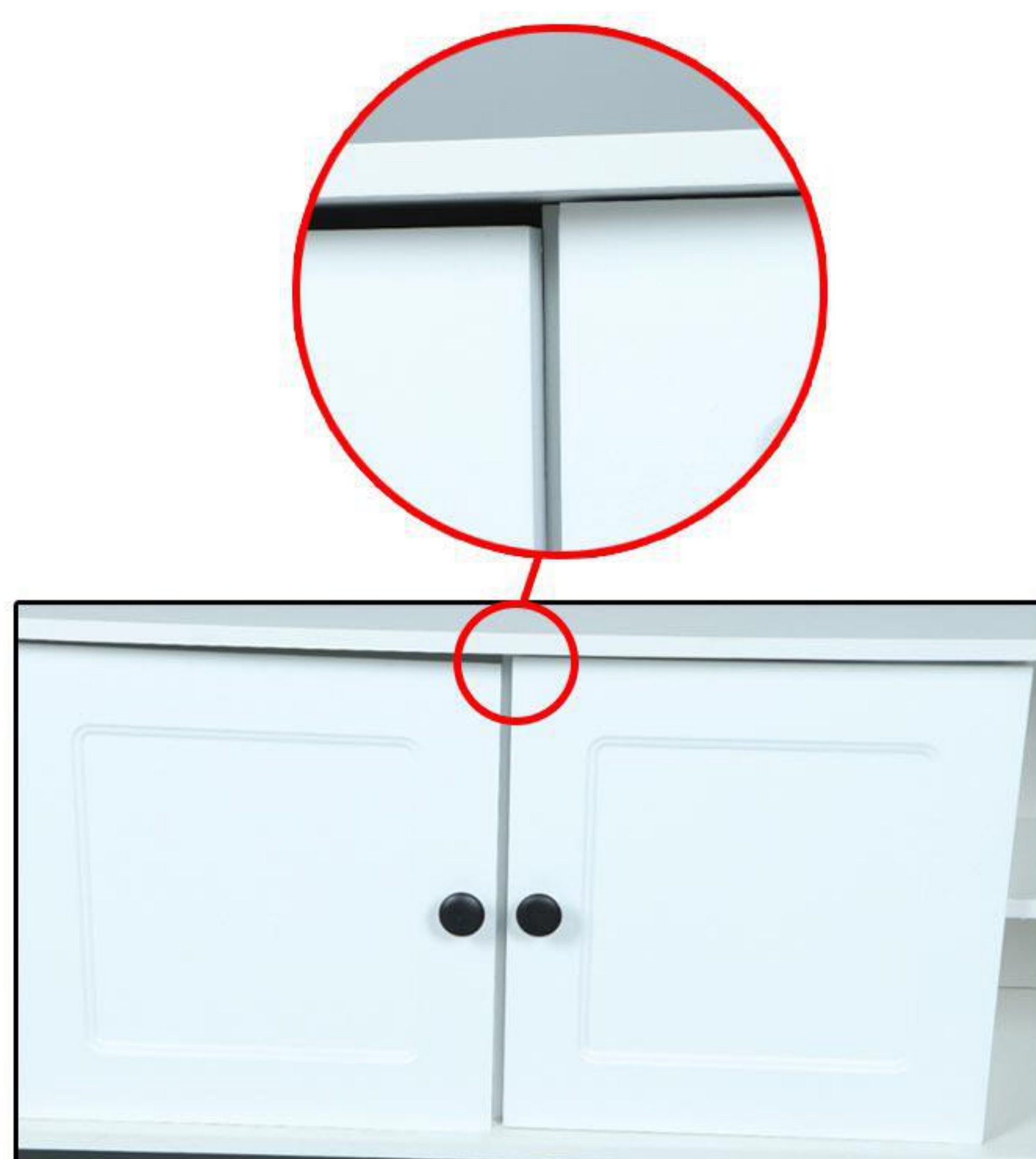

As shown in the picture, loosen the screw pointed by the screwdriver, push the lower door panel and hinge upward, and then tighten the screw. Push the higher door panel and hinges down and tighten the screws.



### door adjustment

The door gap is too large



Adjust the screws on the hinge to tighten the door.

The gap between the door frame and the cabinet is too large



Adjust the screws on the hinge to tighten the door.

The door panel is high and low



Adjust the screws on the hinge to tighten the door.



Adjust the screws on the hinge to tighten the door.

Adjust the screws on the hinge to tighten the door.

<13>Installation complete



Complete drawing